

CASA DELLA CATENA DI TAMBURINI FABRIZIO

CATENE PER ACCUMULO

CATENA SEMPLICE CON UN RULLO FOLLE SUPERIORE

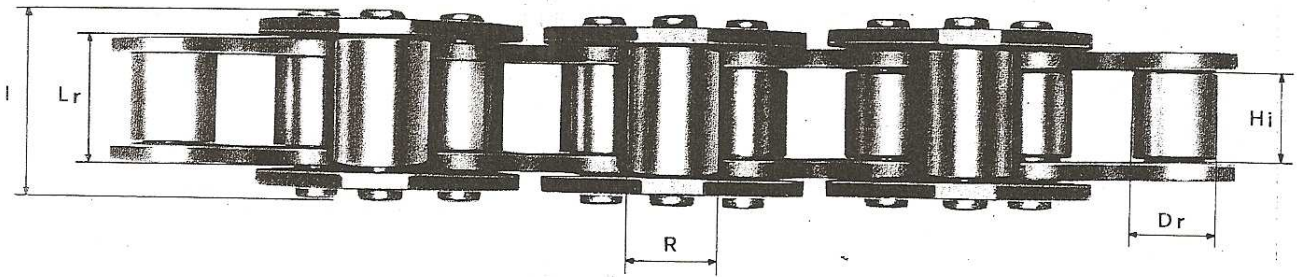
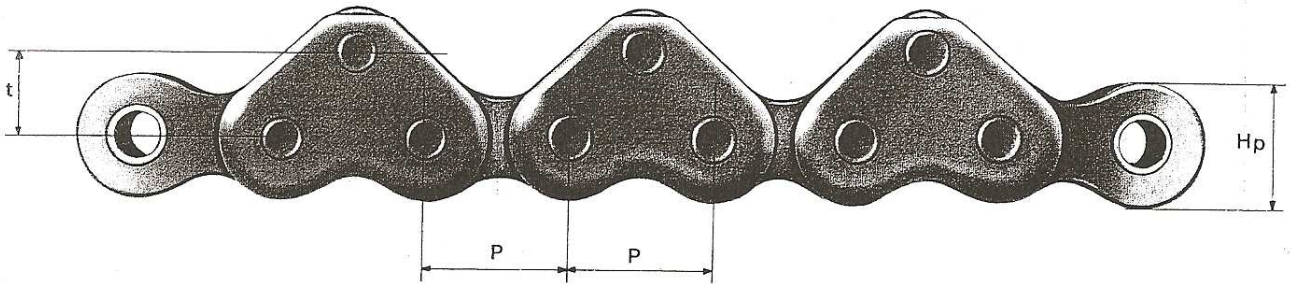

NOSTRO CODICE	passo	largh. interna	diam. rullo	altezza piastra	ingombro perno	diam. rullo folle	larghezza rullo folle	interasse verticale	Carico minimo di rottura Kg.	TRADE MARK
	P mm.	Hi mm.	Dr mm.	Hp mm.	I mm.	R mm.	Lr mm.	t mm.		
1435/ACC	25,40	17,02	15,88	21,0	35,0	30	24	26	6.500	
1475/ACC	31,75	19,56	19,05	27,2	42,0	20	28	19	8.500	

CASA DELLA CATENA DI TAMBURINI FABRIZIO

CATENE PER ACCUMULO

CATENA SEMPLICE CON UN RULLO FOLLE SUPERIORE

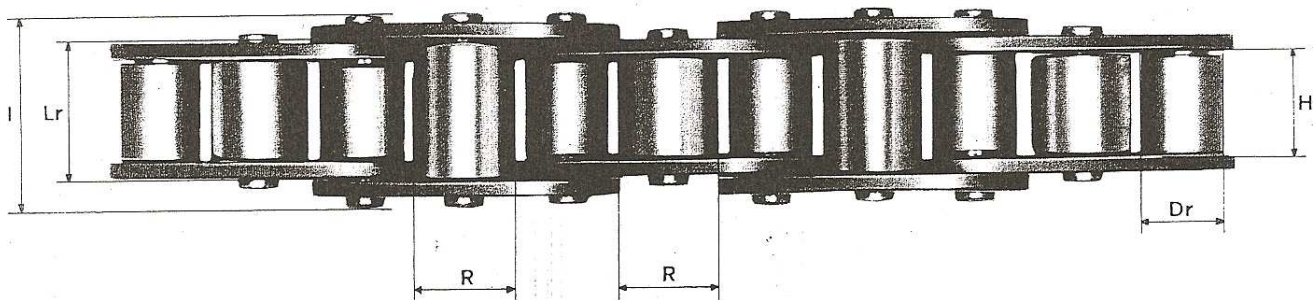
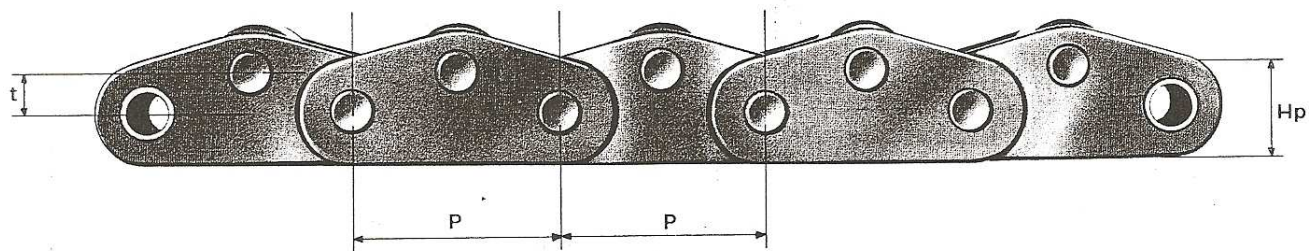

NOSTRO CODICE	passo	largh. interna	diam. rullo	altezza piastra	ingombro perno	diam. rullo folle	larghezza rullo folle	interasse verticale	Carico minimo di rottura Kg.	TRADE MARK
	P mm.	Hi mm.	Dr mm.	Hp mm.	I mm.	R mm.	Lr mm.	t mm.		
5026/ACC	50	26	20	25	47	24	33	10	4.200	

CASA DELLA CATENA DI TAMBURINI FABRIZIO

CATENE PER ACCUMULO

CATENA SEMPLICE CON UN RULLO FOLLE SUPERIORE

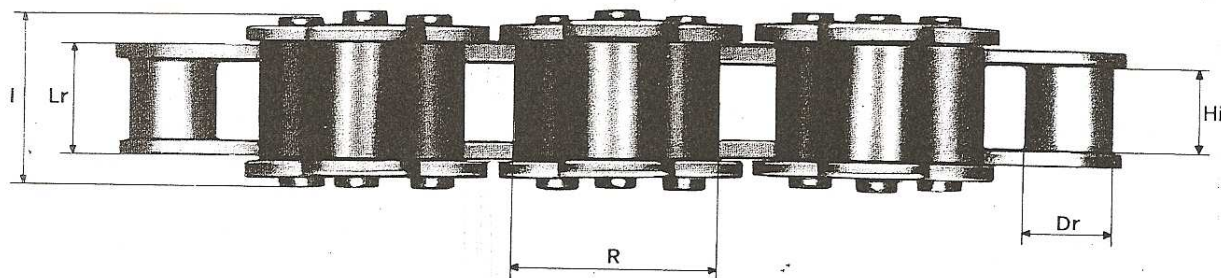
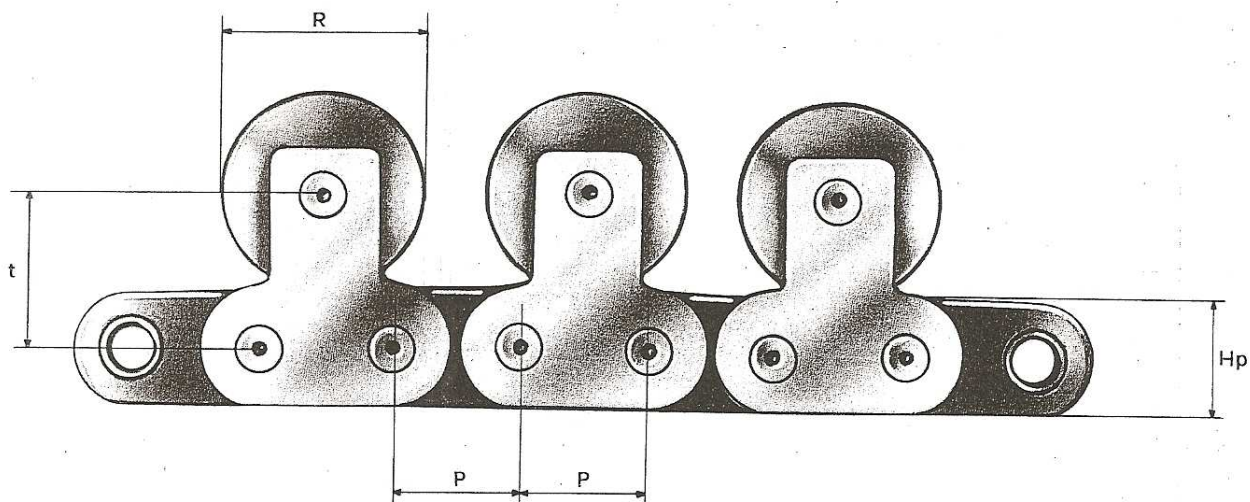

NOSTRO CODICE	passo	largh. interna	diam. rullo	altezza piastra	ingombro perno	diam. rullo folle	larghezza rullo folle	interasse verticale	Carico minimo di rottura Kg.	TRADE MARK
	P mm.	Hi mm.	Dr mm.	Hp mm.	I mm.	R mm.	Lr mm.	t mm.		
E388/ACC	9,525	5,72	6,35	8,26	13,50	12	8,3	10,2	1.000	
E516/ACC	12,70	7,75	8,51	11,90	16,50	15	10,7	14,5	1.900	
E583/ACC	15,875	9,65	10,16	14,73	19,60	20	13,2	18,8	2.500	
E716/ACC	19,05	11,68	12,07	16,13	22,30	20	15,5	*19,5	3.000	
E143/ACC	25,40	17,02	15,88	23,20	36,10	23	24,0	23,6	6.500	

* disponibile anche 17,90

CASA DELLA CATENA DI TAMBURINI FABRIZIO

CATENE PER ACCUMULO

CATENA SEMPLICE CON DUE RULLI SUPERIORI FOLLI

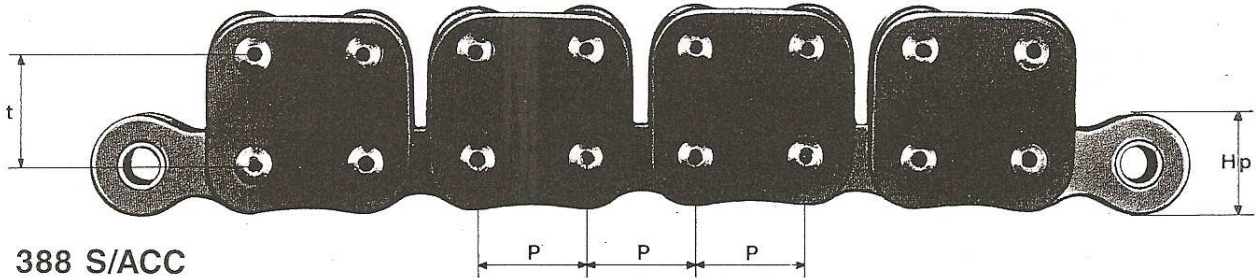

388 S/ACC
516 S/ACC
583 S/ACC
716 S/ACC

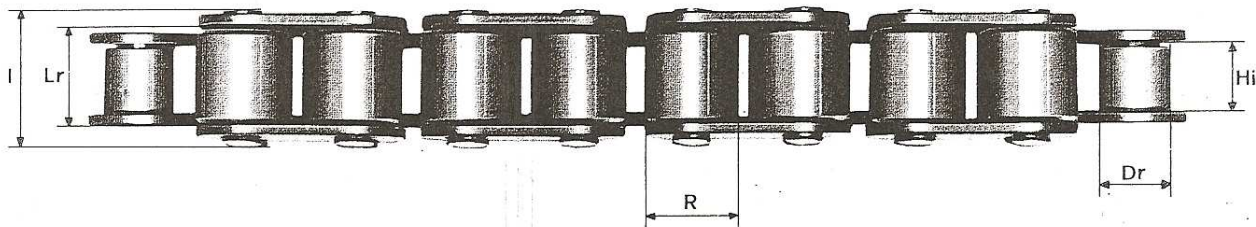

CATENA DOPPIA CON DUE O QUATTRO RULLI SUPERIORI FOLLI

TIPO A 4 RULLI FOLLI

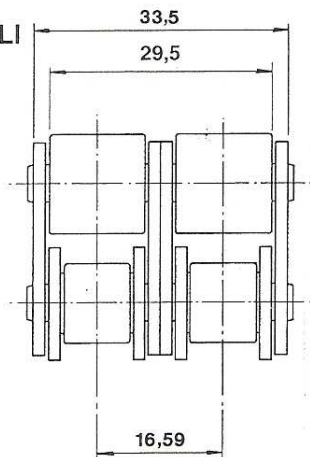

583 D/ACC/A

TIPO A 2 RULLI FOLLI

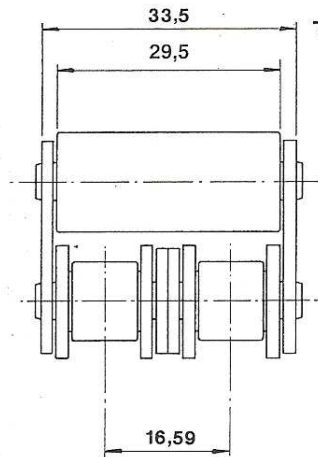

583 D/ACC/B

NOSTRO CODICE	passo	largh. interna	diam. rullo	altezza piastra	ingombro perno	diam. rullo folle	interasse verticale	larghezza rullo folle	Carico minimo di rottura Kg.	TRADE MARK
	P mm.	Hi mm.	Dr mm.	Hp mm.	l mm.	R mm.	t mm.	Lr mm.		
388S/ACC	9,525	5,72	6,35	8,26	13,2	8	10,0	8,3	1.000	
516S/ACC	12,70	7,75	8,51	11,90	17,0	12	13,2	10,7	1.900	
583S/ACC	15,875	9,65	10,16	14,73	20,2	13	15,5	13,8	2.500	
583D/ACC/A	15,875	9,65	10,16	14,73	36,0	13	15,5	13,8	5.000	
583D/ACC/B	15,875	9,65	10,16	14,73	36,0	13	15,5	29,5	5.000	
716S/ACC	19,05	11,68	12,07	16,13	22,3	18	19,0	15,5	3.000	

CASA DELLA CATENA DI TAMBURINI FABRIZIO

CATENE PER ACCUMULO

CATENA TRIPLA CON RULLO FOLLE CENTRALE MONTATO SU BLOCCO

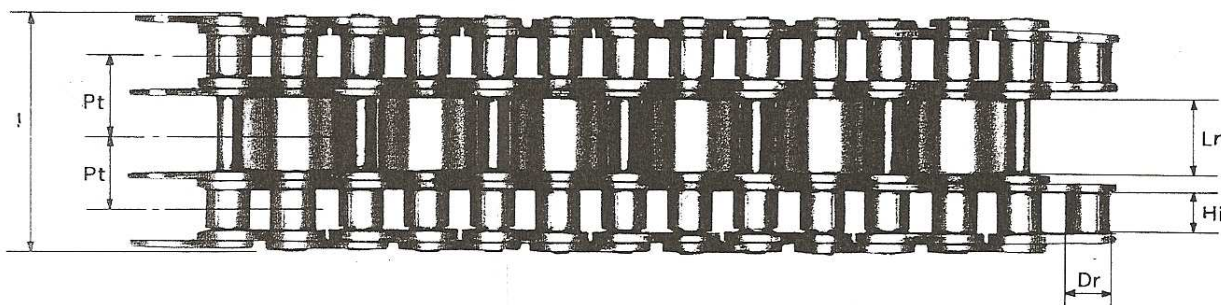
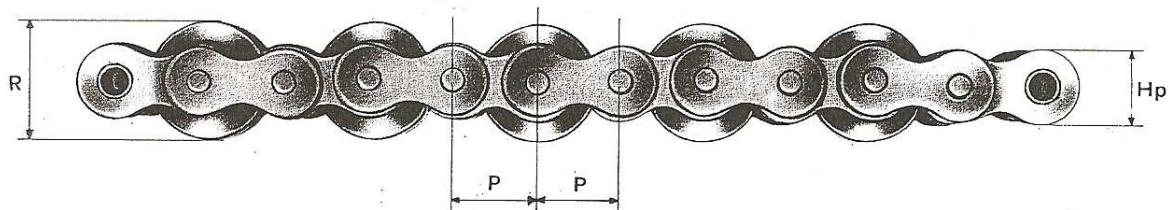

NOSTRO CODICE	passo	largh. interna	diam. rullo	altezza piastra	passo trasvers.	ingombro perno	diam. rullo folle	larghezza rullo folle	Carico minimo di rottura Kg.	TRADE MARK
	P mm.	Hi mm.	Dr mm.	Hp mm.	Pt mm.	I mm.	R mm.	Lr mm.		
388TB/ACC	9,525	5,72	6,35	8,26	10,24	34	12	9,0	1.900	
516TB/ACC	12,70	7,75	8,51	11,90	13,92	45	17	13,5	3.600	
583TB/ACC	15,875	9,65	10,16	14,73	16,59	54	23	16,3	5.000	
716TB/ACC	19,05	11,68	12,07	16,13	19,46	62	28	18,6	6.000	
143TB/ACC	25,40	17,02	15,88	21,00	31,88	99	35	31,5	13.200	
152TB/ACC	38,10	25,40	25,40	33,00	48,36	152	45	45,0	29.000	

CASA DELLA CATENA DI TAMBURINI FABRIZIO

CATENE PER ACCUMULO

CATENA CON RULLO FOLLE CENTRALE (tipo largo)

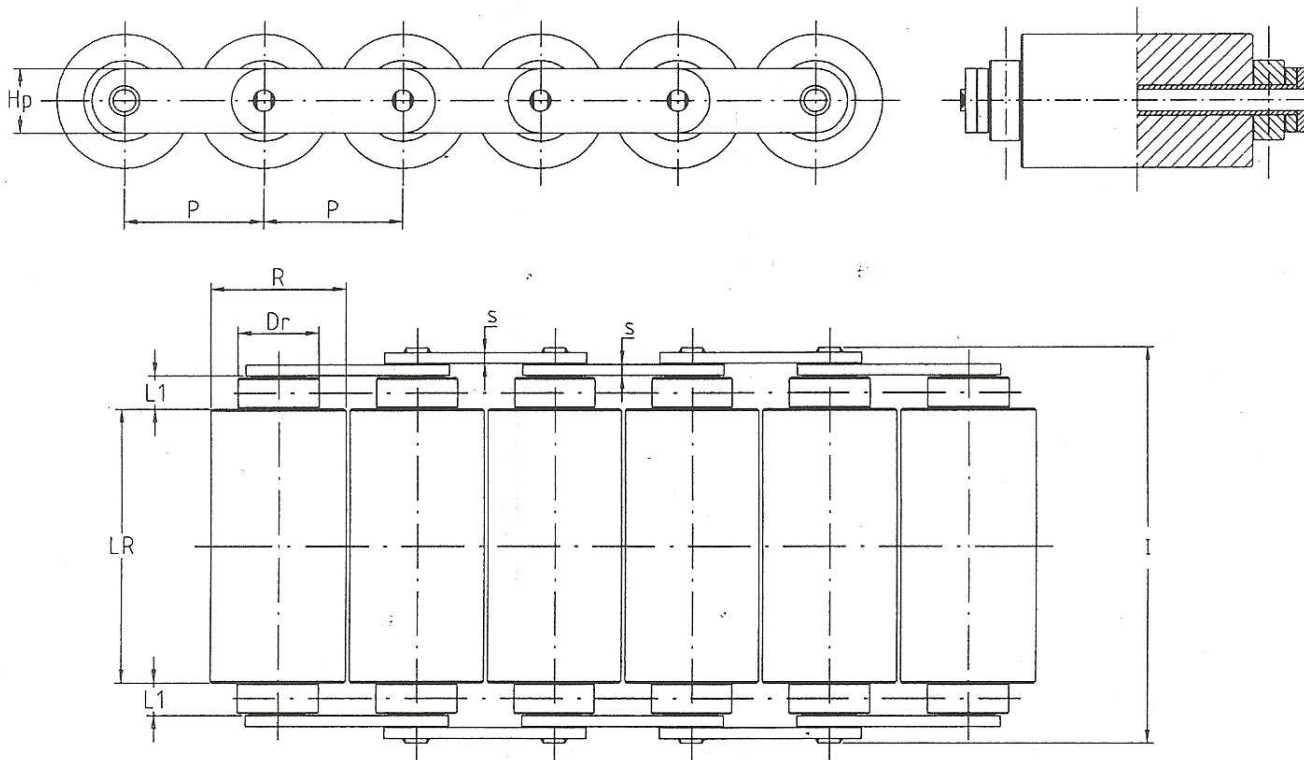

NOSTRO CODICE	passo	diametro rullo piccolo	diametro rullo grande	larghezza rullo piccolo	larghezza rullo grande	altezza max piastre	spessore piastre	ingombro perno	carico minimo di rottura della catena	TRADE MARK
	P mm.	Dr (*) mm.	R (*) mm.	L1 mm.	LR mm.	Hp mm.	s mm.	l mm.	Kg.	
C2062RL/ACC	38,10	22,23	37	8,35	75	18,08	3	108	3.800	

(*) Rulli in plastica / Plastic Rollers.

A richiesta possono essere variate le larghezze e il materiale dei rulli. / On request, different rollers width and material can be supplied.

CASA DELLA CATENA DI TAMBURINI FABRIZIO

CATENE PER ACCUMULO

CATENA SEMPLICE CON TRE RULLI FOLLI SUPERIORI

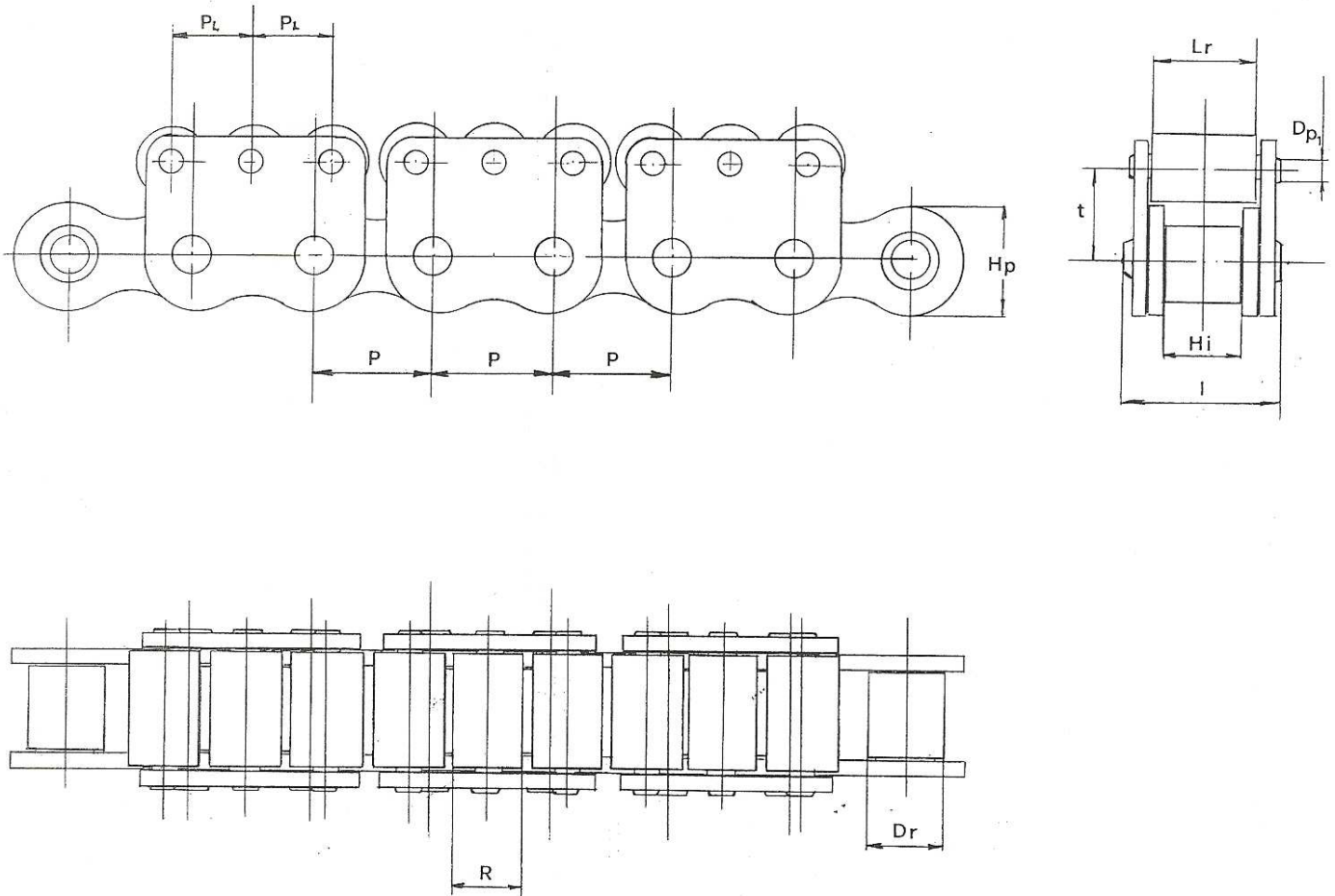

NOSTRO CODICE	passo	largh. interna	diam. rullo	altezza piastra	ingombro perno	diam. rullo folle	larghezza rullo folle	interasse verticale	interasse longitud.	diam. perno sup.	Carico minimo di rottura kg.	TRADE MARK
	P mm.	H _i mm.	D _r mm.	H _p mm.	I mm.	R mm.	L _r mm.	t mm.	P _L mm.	D _{p1} mm.		
143E/ACC	25,40	17,02	15,88	21,0	35,00	15	24	19,9	16,5	5,05	6.500	
147E/ACC	31,75	19,56	19,05	27,0	40,50	20	28	24,0	21,0	8,20	8.500	

CATENE PER ACCUMULO

CATENE A 3 RULLI FOLLI PER TRASPORTATORI AD ACCUMULO

Versione 1

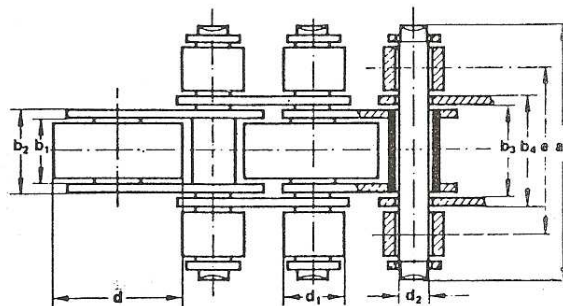
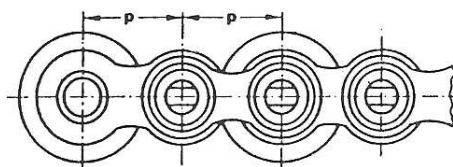
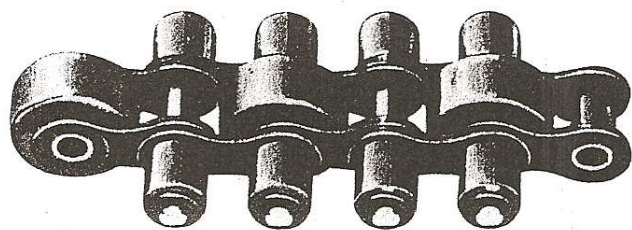

Versione 2

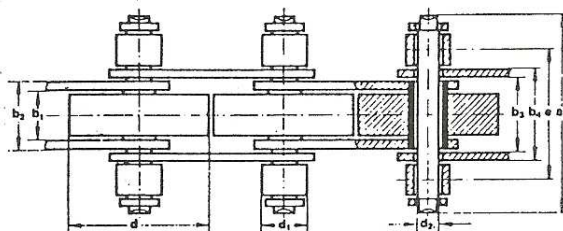
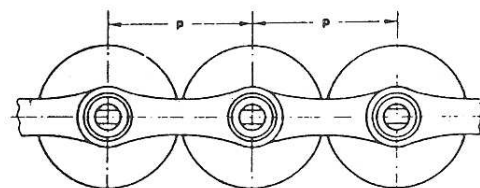

NOSTRO CODICE	Carico minimo di rottura Kg.	Peso per metro Kg.	p mm.	b ₁ mm.	b ₂ mm.	b ₃ mm.	b ₄ mm.	d mm.	d ₁ mm.	d ₂ mm.	e mm.	a ₁ mm.	TRADE MARK
516SRS/ACC	1900	1,505	12,70	7,75	10,8	11,0	14,2	17,0	8,51	4,45	20,2	30,0	
716SRS/ACC	3200	3,100	19,05	11,70	15,6	15,8	19,5	24,0	12,07	5,72	31,5	48,0	
716BOSCH/ACC	3200	2,026	19,05	11,70	15,6	15,8	19,5	26,0	12,00	5,72	29,5	42,0	
143SRS/ACC	6500	7,200	25,40	17,00	25,4	25,8	32,0	38,5	15,88	8,28	44,9	67,9	
1003SRS/ACC	3200	2,600	38,10	11,70	15,6	15,8	19,5	24,0	12,00	5,72	31,5	48,0	
1004SRA/ACC	6500	7,600	50,80	17,00	25,4	25,8	32,0	50,0	15,88	8,28	44,9	67,9	

I tipi 716SRS/ACC e 143SRS/ACC in versione 1. Tipi 1003SRS/ACC e 1004SRS/ACC in versione 2.

I rulli Ø 24/38,5/24/50 possono essere costruiti in acciaio con resistenza temperatura -30° +200° oppure in pollamide con resistenza temperatura -10° +60°.

CASA DELLA CATENA DI TAMBURINI FABRIZIO

CATENE PER ACCUMULO

CATENA TRIPLA CON RULLO FOLLE LATERALE

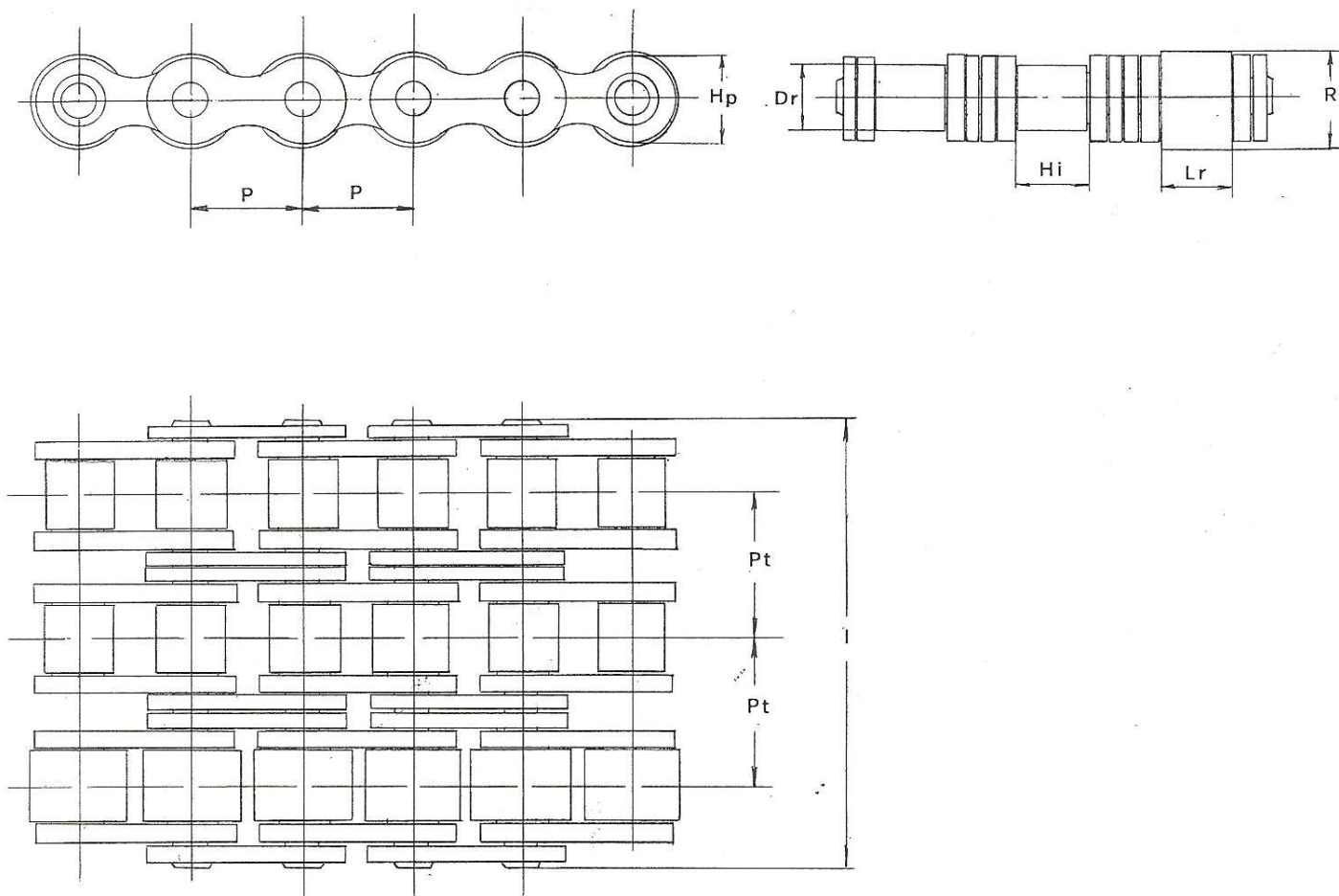

NOSTRO CODICE	passo	largh. interna	diam. rullo	altezza piastra	ingombro perno	passo trasversale	diam. rullo folle	larghezza rullo folle	Carico minimo di rottura Kg.	TRADE MARK
	P mm.	Hi mm.	Dr mm.	Hp mm.	I mm.	Pt mm.	R mm.	Lr mm.		
716RE/ACC	19,05	11,68	12,07	16,13	62,0	19,46	18	11,0	6.000	
143RE/ACC	25,40	17,02	15,88	21,0	99,0	31,88	22	16,5	12.000	

CASA DELLA CATENA DI TAMBURINI FABRIZIO

CATENE PER ACCUMULO

CATENA TRIPLA CON RULLO FOLLE LATERALE

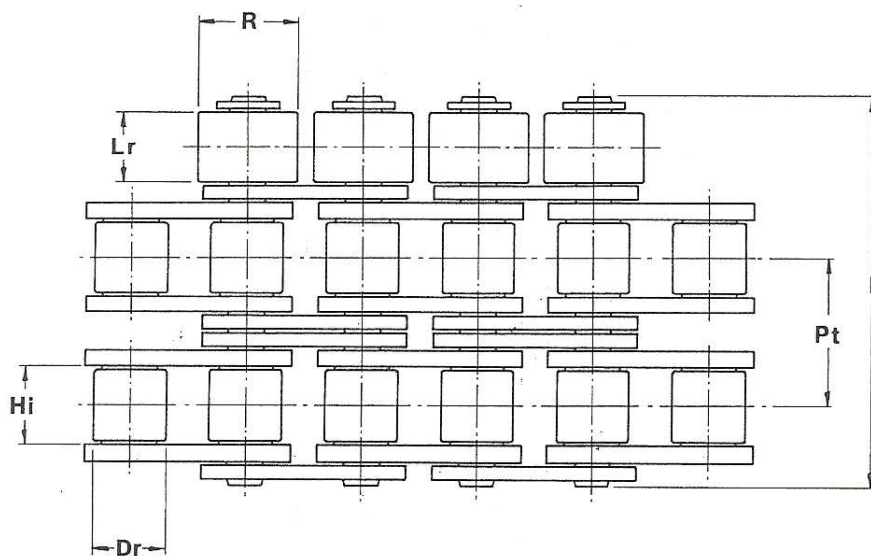
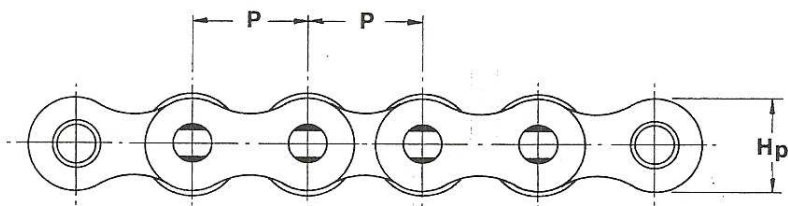

NOSTRO CODICE	passo	largh. interna	diam. rullo	altezza piastra	ingombro perno	passo trasversale	diam. rullo folle	larghezza rullo folle	Carico minimo di rottura Kg.	TRADE MARK
	P mm.	Hi mm.	Dr mm.	Hp mm.	l mm.	Pt mm.	R mm.	Lr mm.		
143SP/ACC	25,4	17,02	15,88	21	88,5	31,88	22	16,5	12.000	

CASA DELLA CATENA DI TAMBURINI FABRIZIO

CATENE PER ACCUMULO

CATENA TRIPLA CON RULLO FOLLE LATERALE

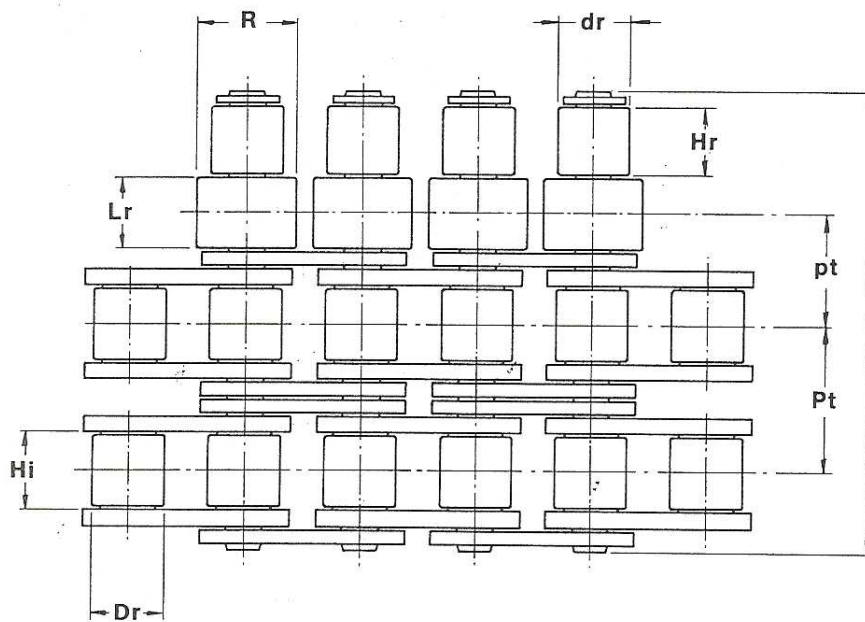
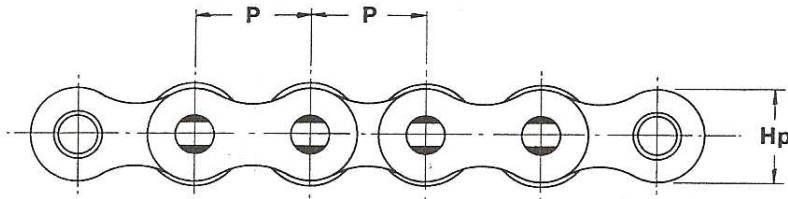

NOSTRO CODICE	passo	largh. interna	diam. rullo	altezza piastra	ingombro perno	passo trasversale	diam. rullo folle	larghezza rullo folle	Larghezza rullo laterale	Carico minimo di rottura	TRADE MARK
	P mm.	Hi mm.	Dr mm.	Hp mm.	I mm.	Pt mm.	R mm.	Lr mm.	HR mm.	Kg.	
143AI/ACC	25,40	17,02	15,88	21	101,5	31,88	22	16,5	16,5	12.000	